

DIMENSIONS IN MILLIMETRES
(DIMENSIONS IN FEET-INCHES)

MODEL	RATING	"A" CLEAR DOOR OPENING	"B" WALL OPENING	"C" FRONT FRAME	"D" RAD. SWING	SHIPPING WEIGHT	SPECIFY WALL THICKNESS
1813	1 HR.	32" X 78"	42½" X 83½"	45⅛" X 84⅓⅙"	39"	795	
1814	1 HR.	40" X 78"	50½" X 83½"	53⅛" X 84⅓⅙"	47"	995	
1823	2 HR.	32" X 78"	42½" X 83½"	45⅛" X 84⅓⅙"	39"	825	
1824	2 HR.	40" X 78"	50½" X 83½"	53⅛" X 84⅓⅙"	47"	1,025	
1843	4 HR.	32" X 78"	42½" X 83½"	45⅛" X 84⅓⅙"	39"	845	
1844	4 HR.	40" X 78"	50½" X 83½"	53⅛" X 84⅓⅙"	47"	1,040	
1863	6 HR.	32" X 78"	42½" X 83½"	45⅛" X 84⅓⅙"	39"	875	
1864	6 HR.	40" X 78"	50½" X 83½"	53⅛" X 84⅓⅙"	47"	1,070	

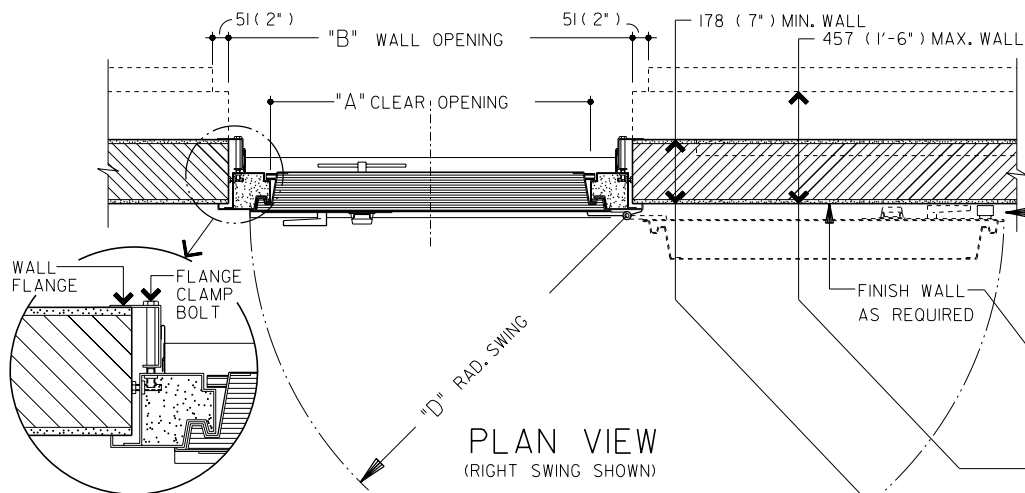

NOTE:
STANDARD WALL FLANGES ARE AVAILABLE TO GRIP WALLS BETWEEN 178mm (7") MIN. TO 457mm (18") MAX. IN 51mm (2") INCREMENTS. FOR THE PROPER WALL FLANGE, THE WALL THICKNESS MUST BE SPECIFIED.
THE FINISH OF THE WALL SHOULD BE APPLIED AND DRIED BEFORE THE DOOR IS SET

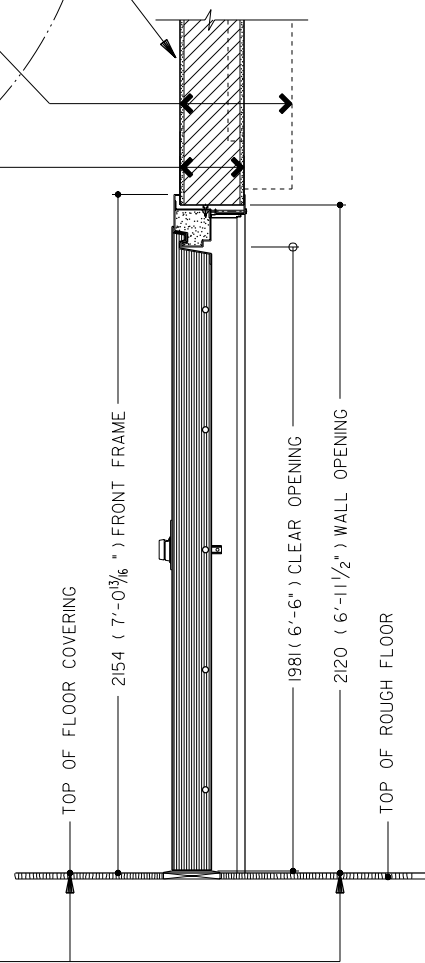
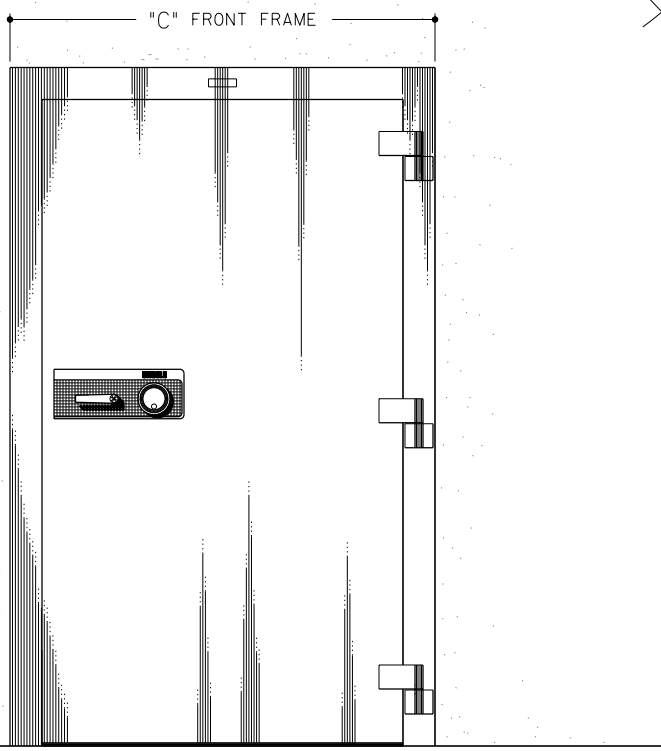

DIMENSION SHOWN ARE TO TOP OF FLOOR COVERING (TOP OF CARPET, TILE, ETC.) ALLOW FOR THICKNESS OF FLOOR COVERING IN PREPARING THE OPENING. USE FILL UNDER SILL (BY OTHERS AT INSTALLATION) TO MAINTAIN CLEARANCE OF 10mm (⅜") FROM DOOR TO TOP OF FLOOR COVERING.

STANDARD ITEMS:

1. U.L. FIRE ENDURANCE, U.L. RELOCK, U.L. GROUP II COMBINATION LOCK.
2. PANIC ESCAPE MECHANISM; ALLOWS A PERSON LOCKED IN VAULT TO OPEN THE DOOR FROM THE INSIDE.
3. COLORS

- PLANTINUM
- DAWN
- GRAY I
- PLAZZA GRAY
- BLACK
- TOPAZ
- LIGHT CHARCOAL

OPTIONAL ITEMS:

1. KEYLOCKING BOLT THROW HANDLE.
2. KEYLOCKING DIAL.
3. DUAL CONTROL; SECOND COMBINATION LOCK.
4. DAYGATE (SEE BACK PAGE)
5. COLORS

- SILVER GRAY
- SEA GRAY
- AQUA
- WILLIAMSBURG GREEN
- BRITTANY BLUE
- TAN I
- NUTMEG
- ROSEWOOD
- WINEBERRY

NOTE:

STANDARD WALL FLANGES ARE AVAILABLE TO GRIP WALLS BETWEEN 178mm (7") MIN. TO 457mm (18") MAX. IN 51mm (2") INCREMENTS. FOR THE PROPER WALL FLANGE, THE WALL THICKNESS MUST BE SPECIFIED.

THE FINISH OF THE WALL SHOULD BE APPLIED AND DRIED BEFORE THE DOOR IS SET

DIMENSIONS IN MILLIMETRES
(DIMENSIONS IN FEET-INCHES)

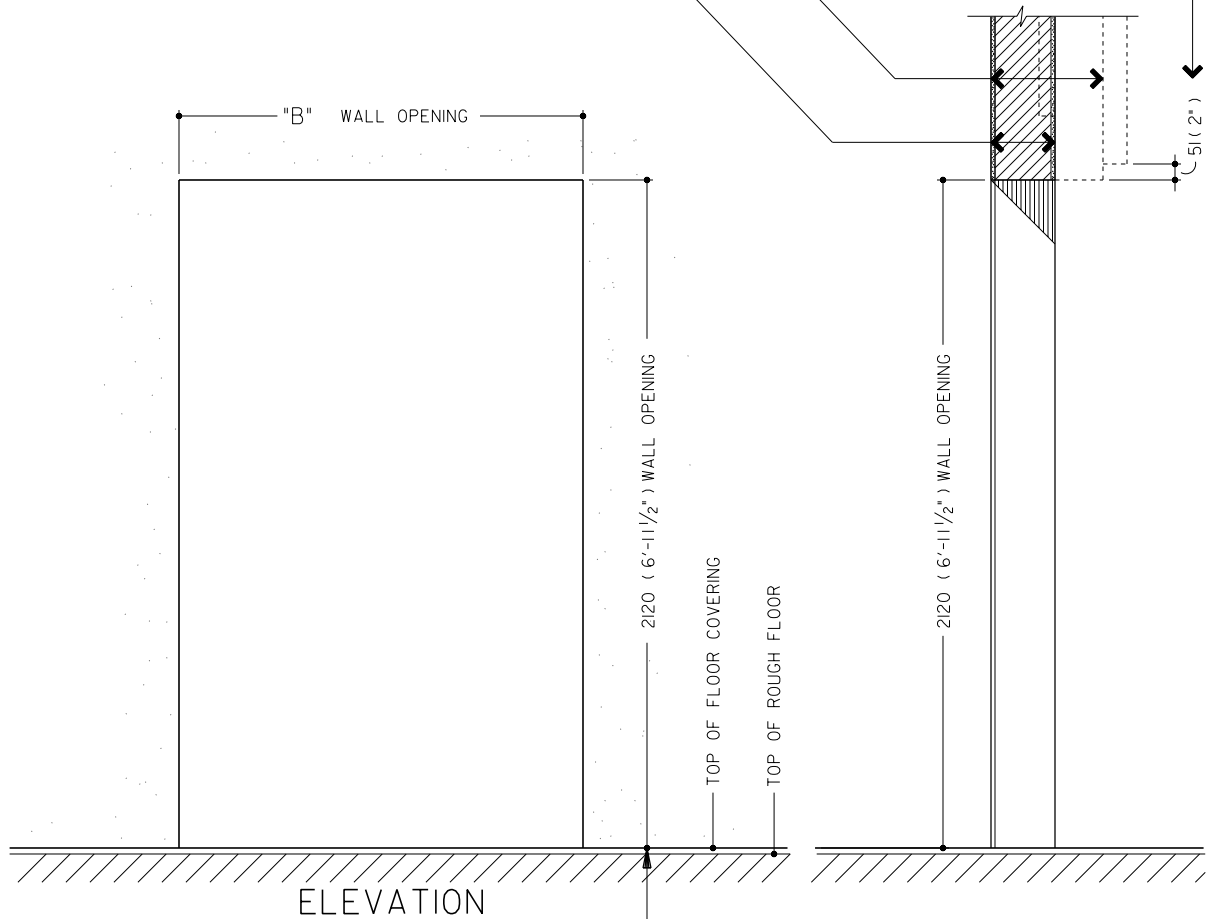
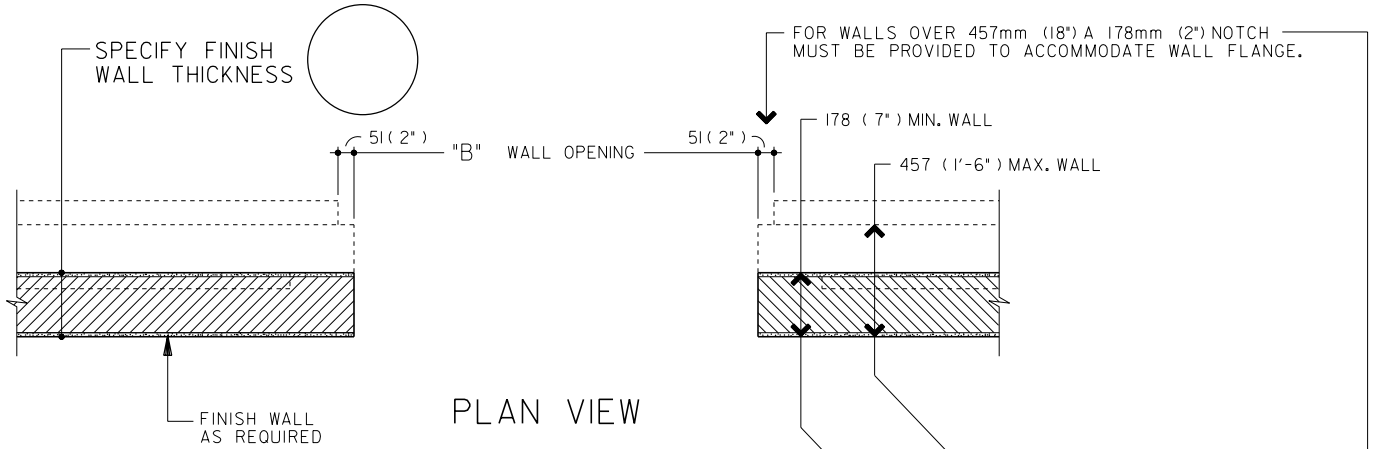
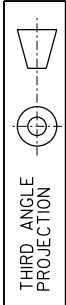

DIMENSION SHOWN ARE TO TOP OF FLOOR COVERING (TOP OF CARPET, TILE, ETC.) ALLOW FOR THICKNESS OF FLOOR COVERING IN PREPARING THE OPENING. USE FILL UNDER SILL (BY OTHERS AT INSTALLATION) TO MAINTAIN CLEARANCE OF 10mm (3/8\") FROM DOOR TO TOP OF FLOOR COVERING.

CALL 1-800-999-3600

DIMENSIONS IN MILLIMETRES
(DIMENSIONS IN FEET-INCHES)

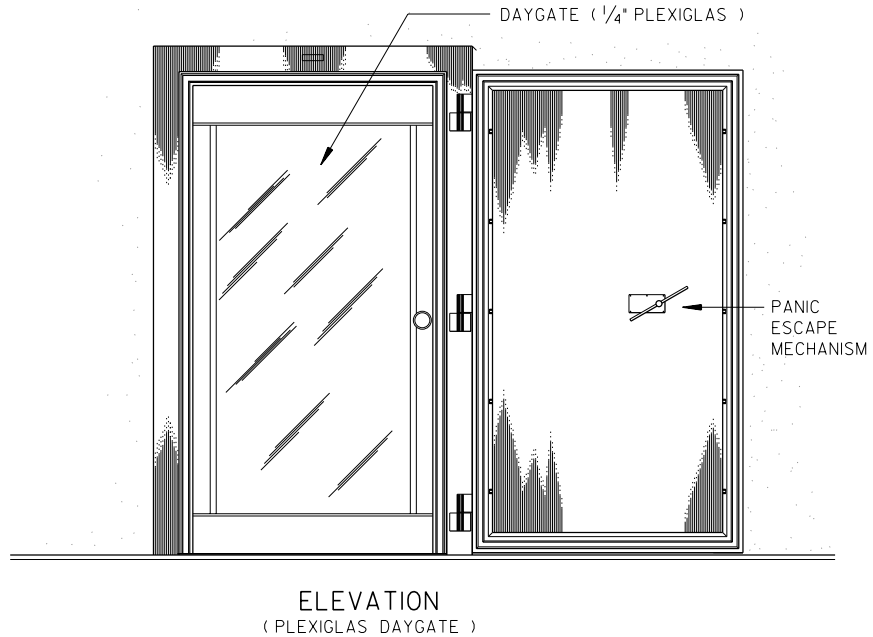
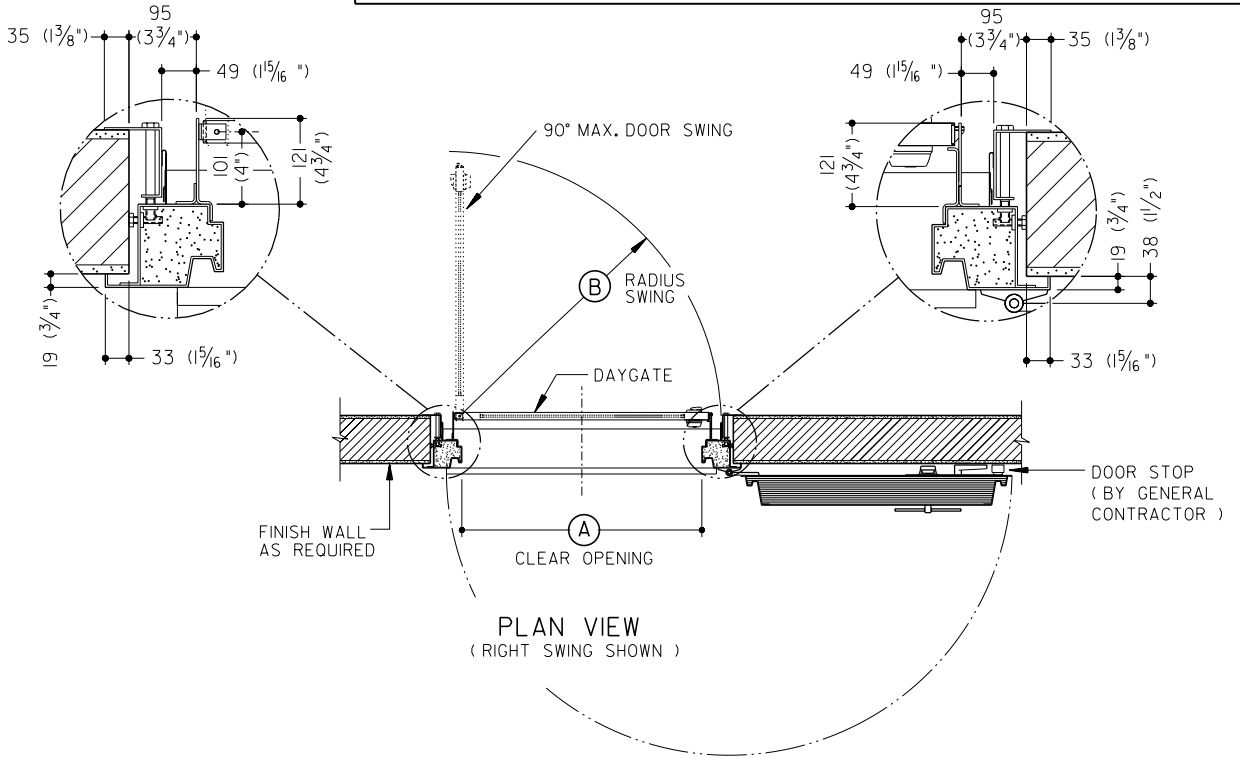
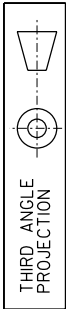

OPTIONAL DAYGATE (SELECT APPROPRIATE MODEL)

DAYGATE MODEL NUMBER	"A" DIMENSION	"B" DIMENSION	USED WITH VAULT DOOR MODEL NO.
154-75 PLEXIGLAS	813 (2'-8")	854 (2'-9 5/8")	1813, 1823, 1843, 1863
154-76 PLEXIGLAS	1016 (3'-4")	1057 (3'-5 5/8")	1814, 1824, 1844, 1864