

CALL 1-800-999-3600

LANEL KIT:

LNL-500 (I9-055151-000A)

TWO DOWNSTREAM 2-WIRE RS-485 CHANNELS OR ONE 4-WIRE RS-485 CHANNEL.
UP TO 32 READERS OR 16 DEVICES ON A SINGLE INTELLIGENT SYSTEM CONTROLLER.

SPECIFICATIONS

CONSTRUCTION	16 GAUGE STEEL GLOSS GRAY
WEIGHT	20 LBS. (9.07 KG) WITH BATT/HARDWARE
POWER SOURCE INPUT	120VAC, 50/60HZ, 1.45 AMP
POWER SUPPLY OUTPUT VOLTAGE	12VDC, 4 AMPS 24VDC, 3 AMPS
TEMPERATURE	32°F TO 158°F (0°C TO 70°C)
TAMPER SWITCH PROVIDED W/ENCLOSURE.	

INSTALLATION NOTES

MOUNTING HARDWARE TO BE COMPATIBLE WITH WALL CONSTRUCTION AND ADEQUATE TO SUPPORT WEIGHT OF UNIT.

REFERENCE INSTALLATION MANUAL FOR PROPER METHOD OF INSTALLATION.

CONTACT LOCAL SALES/SERVICE FOR VARIOUS MODEL AND APPLICATION NEEDS.

DIMENSIONS IN FEET-INCHES
(DIMENSIONS IN METRES)



THIRD ANGLE
PROJECTION

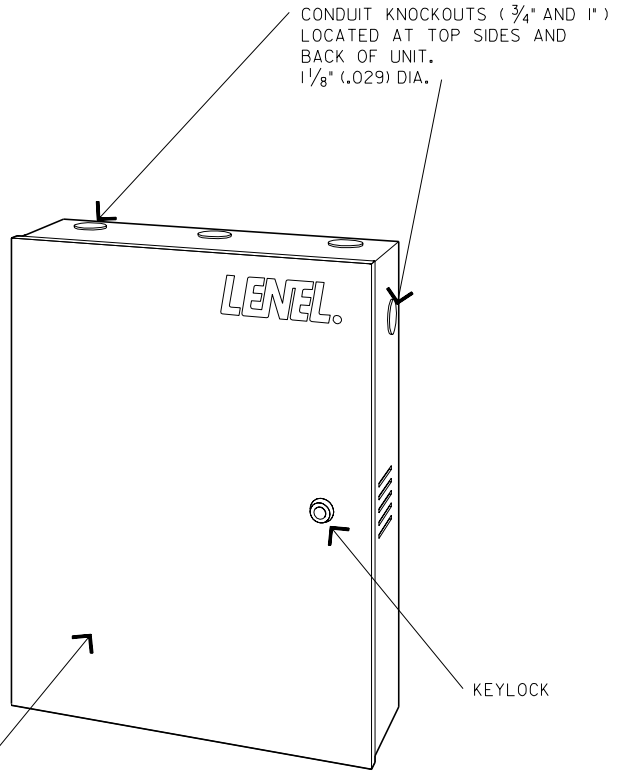

ENCLOSURE (ONLY)
LNL-CTX (I9-055185-000A)
LARGE ENCLOSURE (OPTIONAL)
LNL-CTX-6 (I9-055186-000A)

PERSPECTIVE

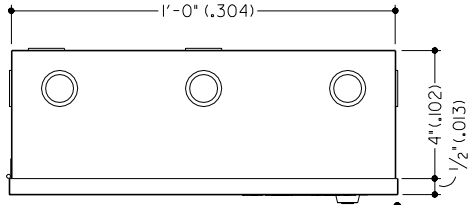

PLAN VIEW

DOOR SWING

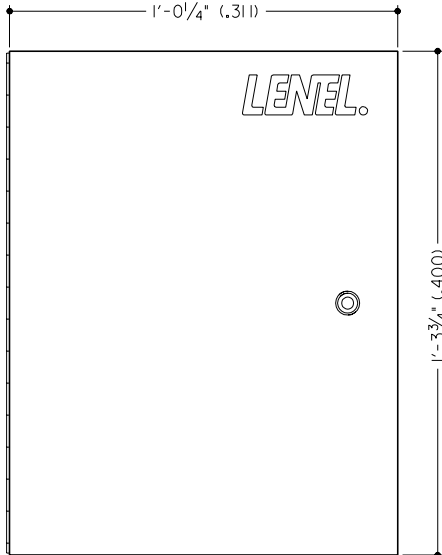

FRONT VIEW

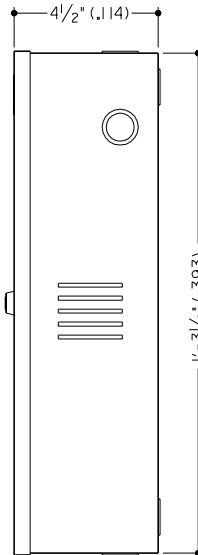

SIDE VIEW

(3) 3/16" (.004) DIA. HOLES PROVIDED FOR MOUNTING
ENCLOSURE UNIT.

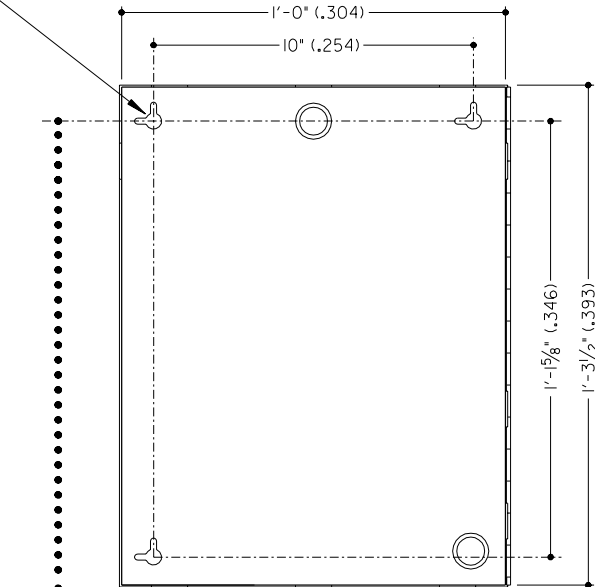

BACK VIEW





DIMENSIONS IN FEET-INCHES
(DIMENSIONS IN METRES)

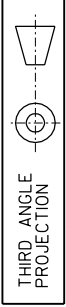

THIRD ANGLE
PROJECTION

*ALL DIMENSIONS AND DESIGN CRITERIA
SUBJECT TO CHANGE WITHOUT NOTICE*

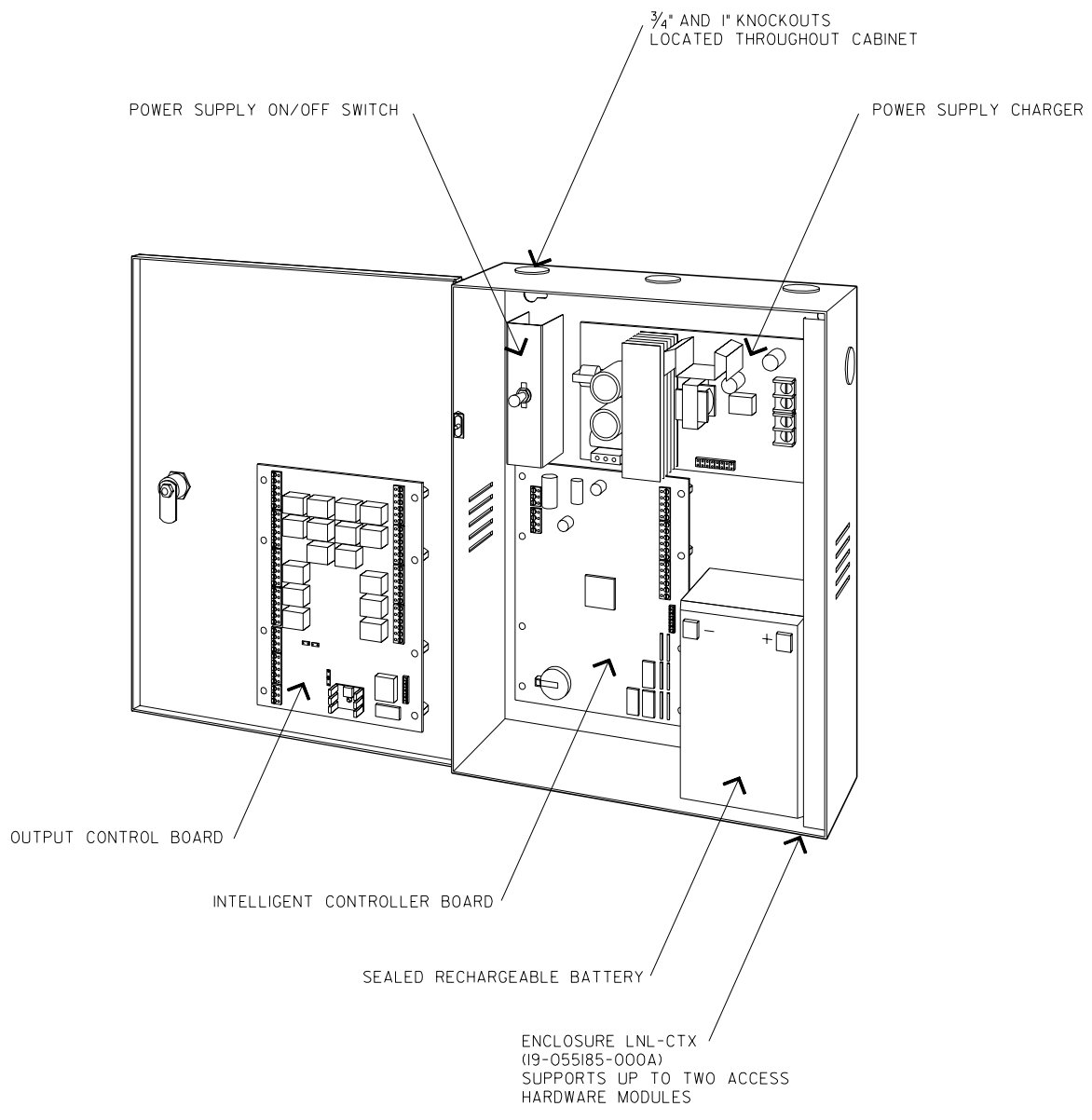

CALL 1-800-999-3600

DIMENSIONS IN FEET-INCHES
(DIMENSIONS IN METRES)

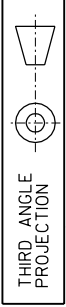

PAGE 3 OF 4

*ALL DIMENSIONS AND DESIGN CRITERIA
SUBJECT TO CHANGE WITHOUT NOTICE*

FILE NO. 170-390 REV. 0

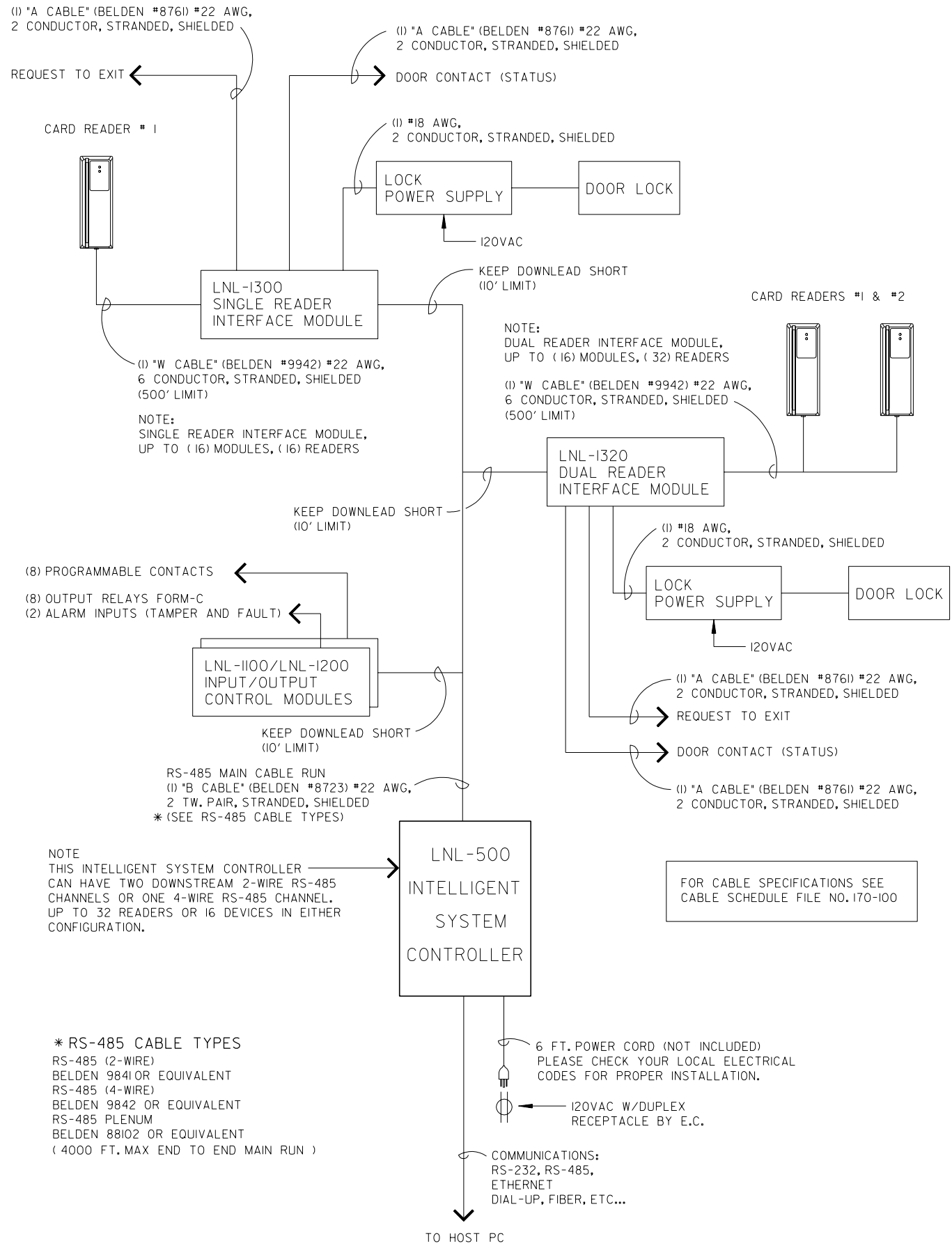

- * RS-485 CABLE TYPES**
- RS-485 (2-WIRE)
 - BELDEN 9841 OR EQUIVALENT
 - RS-485 (4-WIRE)
 - BELDEN 9842 OR EQUIVALENT
 - RS-485 PLENUM
 - BELDEN 88102 OR EQUIVALENT
 - (4000 FT. MAX END TO END MAIN RUN)



SPECIFICATIONS

CONSTRUCTION — 16 GAUGE STEEL
GLOSS GRAY

WEIGHT — 18 LBS. (8.16 KG)
WITH OUT BATT/HARDWARE

TAMPER SWITCH PROVIDED W/ENCLOSURE.

SUPPORTS UP TO SIX ACCESS CONTROL MODULES.

NOTE:
MOUNTING HARDWARE TO BE COMPATIBLE WITH
WALL CONSTRUCTION AND ADEQUATE TO SUPPORT
WEIGHT OF UNIT.

COMPLETE POWER SUPPLY/CHARGER CONFIGURATION
WITH THIS SIZE ENCLOSURE.
LNL-AL600ULX-4CB6 (I9-055184-000A)

CONTACT LOCAL SALES/SERVICE
FOR VARIOUS MODEL AND
APPLICATION NEEDS.

DIMENSIONS IN FEET-INCHES
(DIMENSIONS IN METRES)

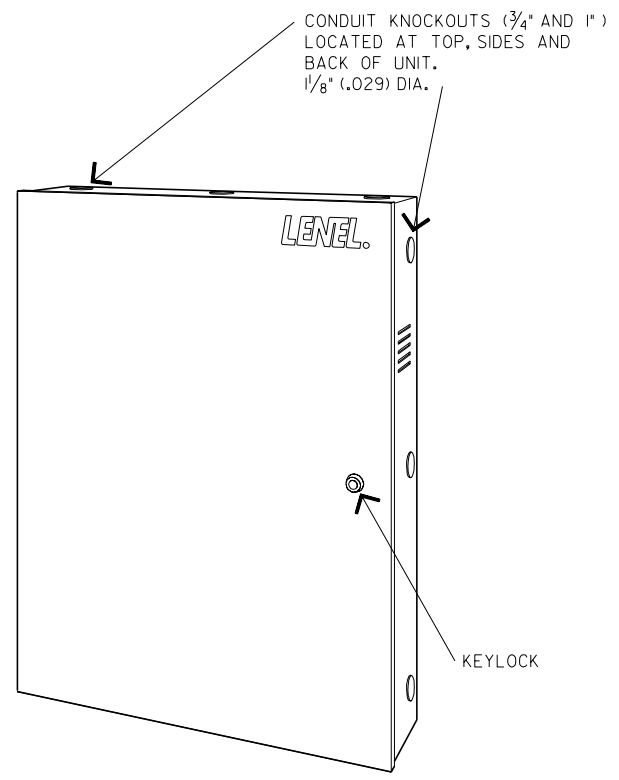
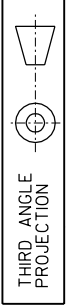

PERSPECTIVE

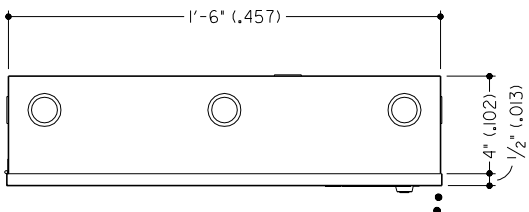

PLAN VIEW

DOOR SWING

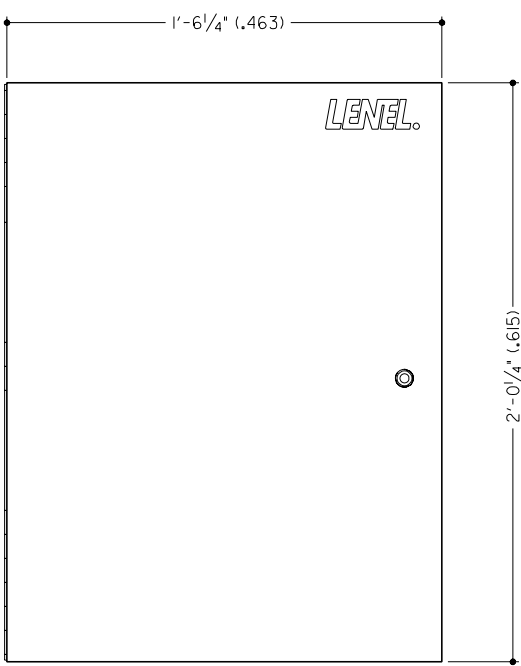

FRONT VIEW

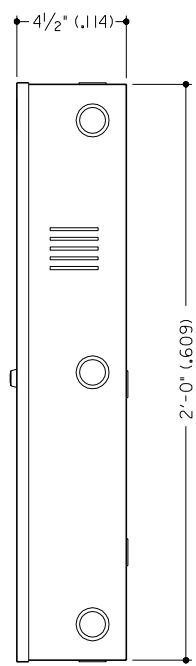

SIDE VIEW

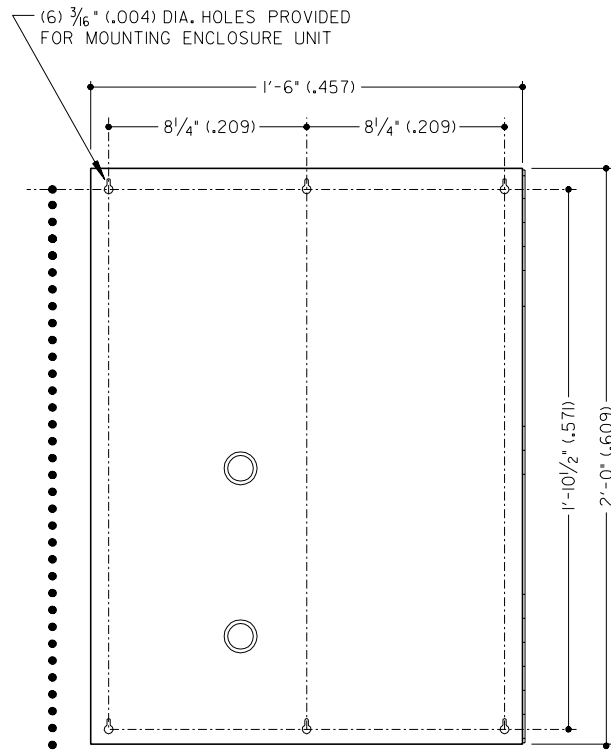

BACK VIEW

5'-6\" (1.676) TO
FINISHED FLOOR

ENCLOSURE LNL-CTX-6 (I9-055186-000A)